



# MOREY Production

## VOLETS PVC



## Volet penture contre penture

disponible en couleur vert pastel ou bleu  
 • plus-value + 20 %

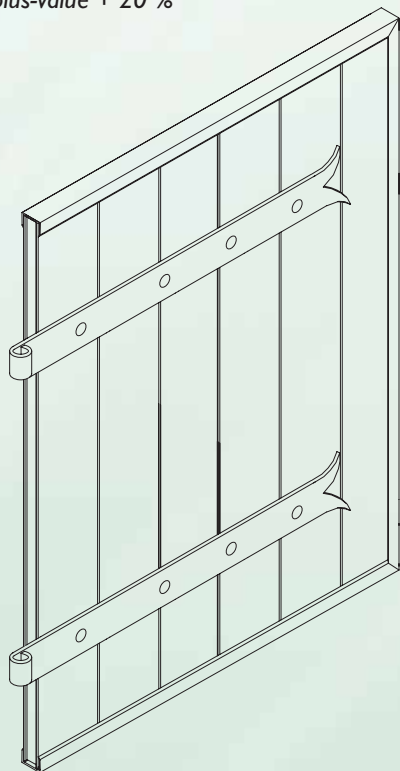

## Volet barre écharpe

non disponible en couleur

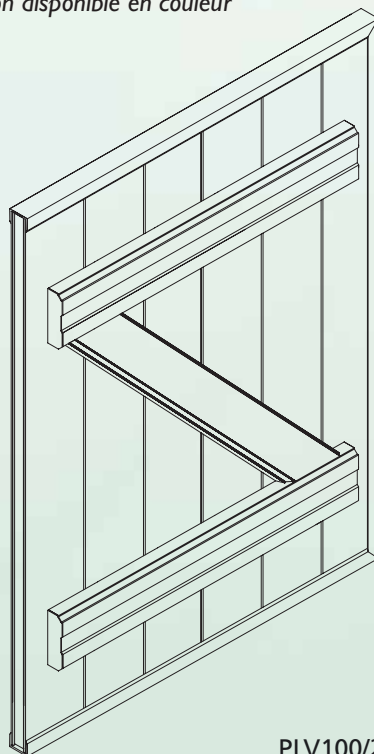

## Volet barre sans écharpe

non disponible en couleur

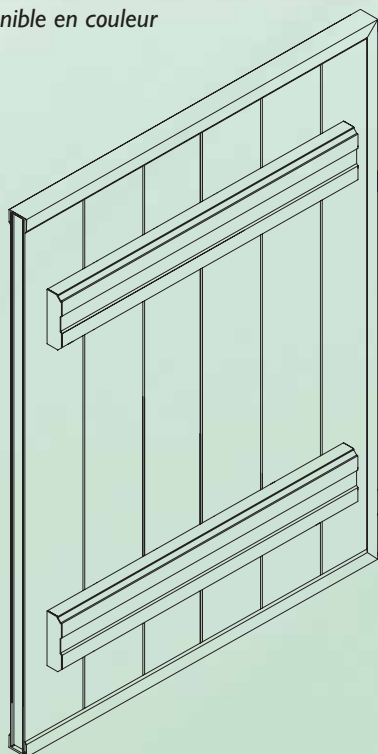

PLV100/24 P50

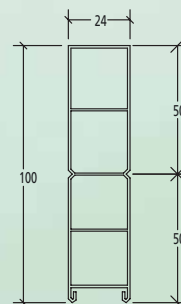

TR 020/21

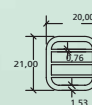

PL 300/24\_P100

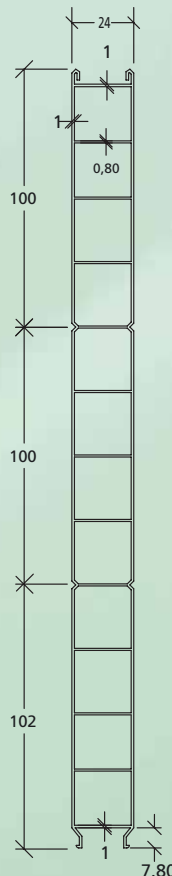

PL 300/24\_P50

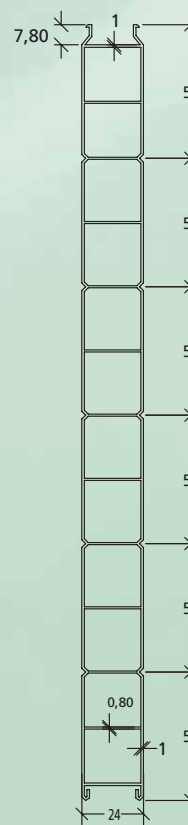

PL100/24



PL218/24

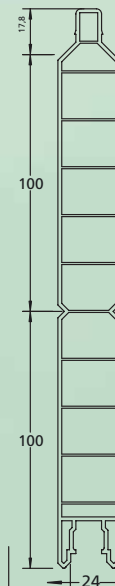

### Produit

PL 300/24_P100	Planche 300 x 24 pas de 100
PL 300/24_P50	Planche 300 x 24 pas de 50
PL 218/24	Planche 218 x 24
PL 100/24	Planche 100 x 24
TR 020/21	Tube de renfort
PLV 100/24_P50	Planche 100 x 24 pas de 50

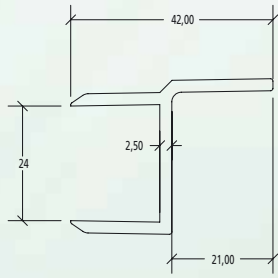

**BATTUE 42 X 24**

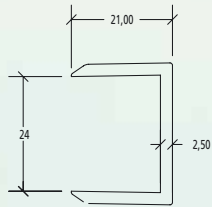

**U 21 X 24**

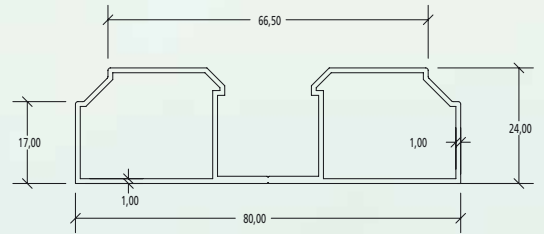

**TRAVERSE**

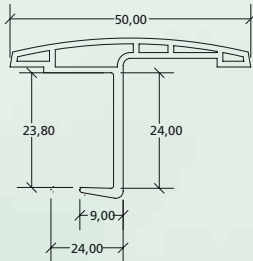

**BATTUE MOULURE 50 X 9 OU 50 X 24**

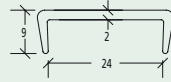

**U 9 x 24**

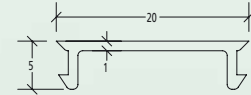

**CLIP TRAVERSE**

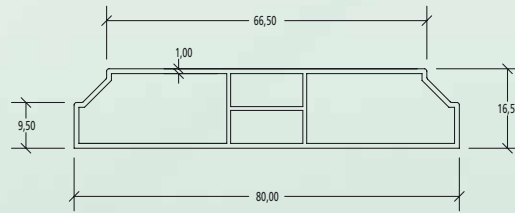

**BARRE A ECHARPE**



**Arrêt marseillais en composite**



**Dardenne en alu noir pour volet 1 et 2 vantaux  
Dardenne alu et composite pour les volets 3 et 4 vantaux**



**Gond composite**

**Tringle espagnolette en alu et autres accessoires, lacet, crochet en composite**



**Contre penture en alu**



**Penture en alu**

VOS RÉF :



### 3 prises de cote différentes pour les volets

#### SUR MAISON NEUVE (donner la dimension de vos ouvertures)

dimension de la fenêtre (HXL)	Quantité	1V	2V	3V	4V	PD	PG	FAP	PVC blanc	PVC bleu	PVC vert	P/CP	TRA/ECH	P/TRA	REF client
H XL															
H XL															
H XL															
H XL															
H XL															
H XL															
H XL															

#### COTE TABLEAU (dimension extérieur de l'embrasure pour maison crépi)

dimension tableau	Quantité	1V	2V	3V	4V	PD	PG	FAP	PVC blanc	PVC bleu	PVC vert	P/CP	TRA/ECH	P/TRA	REF client
H XL															
H XL															
H XL															
H XL															
H XL															
H XL															
H XL															

#### COTE FABRICATION (dimension exacte du volet à réaliser sans jeu de fonctionnement)

dimension fabrication	Quantité	1V	2V	3V	4V	PD	PG	FAP	PVC blanc	PVC bleu	PVC vert	P/CP	TRA/ECH	P/TRA	REF client
H XL															
H XL															
H XL															
H XL															
H XL															
H XL															
H XL															

FAP = ferrage à part

TRA/ECH = traverse + écharpe PVC en Z

P/TRA = penture + traverse PVC

P/CP = penture + contre penture

à nous retourner complète  
au 04 71 57 98 74

REMARQUES ou QUESTIONS

BON POUR ACCORD

<b>PG</b> extérieur <input type="checkbox"/>	<b>PG</b> extérieur <input type="checkbox"/>
<b>PG</b> intérieur <input type="checkbox"/>	<b>PG</b> intérieur <input type="checkbox"/>

Date :

Signature :